

# Data Sheet



Article number: 0108059

Description: Retaining ring JK 42 DIN 984

## Measures

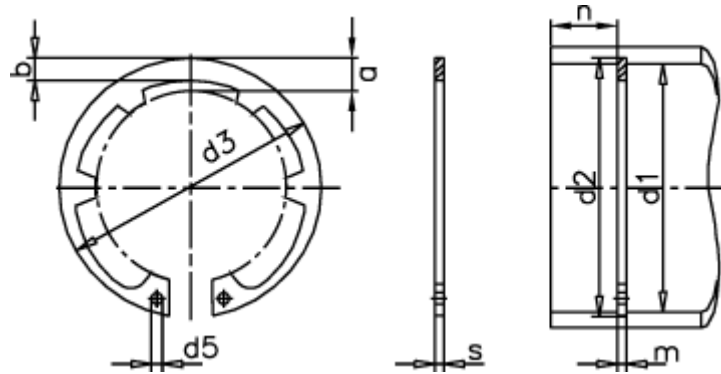

a max	= 7.2	FN kN	= 28.4	s	= 1.75
AN mm <sup>2</sup>	= 170.0	FRg kN	= 8.4	t	= 1.25
b	= 4.1	FR kN	= 44.7	tol	= +0,25
d1	= 42	g	= 2.0	tol	= -0.06
d2	= 44.5	K kN-mm	= 80.9	tol	= +0,90-0,39
d3	= 45.5	m min	= 1.85	Tong	= ZGJ-3
d5 min	= 2.5	Nominal drive	= 3.8	Weight kg/1000	= 6.00
Description	= JK 42	Number of serrations	= 6		